

# A coaxial HOM coupler for a superconducting RF cavity and its low-power measurement results

SUN An(孙安)<sup>1,4,1)</sup> TANG Ya-Zhe(唐亚哲)<sup>2</sup> ZHANG Li-Ping(张力平)<sup>3</sup>  
LI Ying-Min (李英民)<sup>4</sup> Han-Sung Kim<sup>4</sup>

<sup>1</sup> Pohang Accelerator Laboratory, POSTECH, Pohang, Kyung-Buk 790-784, Republic of Korea

<sup>2</sup> College of Science and Engineering, City University of Hong Kong, Kowloon, Hong Kong, China

<sup>3</sup> Construction Machinery School, Chang'an University, Xi'an 710064, China

<sup>4</sup> PEFP, Korea Atomic Energy Research Institute, Daejeon 305-353, Republic of Korea

**Abstract:** A resonant buildup of beam-induced fields in a superconducting radio frequency (RF) cavity may make a beam unstable or a superconducting RF cavity quench. Higher-order mode (HOM) couplers are used for damping higher-order modes to avoid such a resonant buildup. A coaxial HOM coupler based on the TTF (TESLA Test Facility) HOM coupler has been designed for the superconducting RF cavities at the Proton Engineering Frontier Project (PEFP) in order to overcome notch frequency shift and feed-through tip melting issues. In order to confirm the HOM coupler design and finalize its structural dimensions, two prototype HOM couplers have been fabricated and tested. Low-power testing and measurement of the HOM couplers has shown that the HOM coupler has good filter properties and can fully meet the damping requirements of the PEFP low-beta superconducting RF linac.

**Key words:** superconducting RF accelerator, higher-order mode (HOM), HOM damping, coaxial HOM coupler, HOM coupler design

**PACS:** 84.90.-a, 85.25.Am, 42.79.Gn      **DOI:** 10.1088/1674-1137/35/3/017

## 1 Introduction

A superconducting RF (SRF) accelerator is part of the accelerating structure of new-generation particle accelerators [1–5]. The accelerating mode of a SRF accelerator built with an elliptical cavity is TM<sub>010</sub>  $\pi$ . Aside from the TM<sub>010</sub>  $\pi$  mode, there are a lot of other eigenmodes in a SRF cavity, which are called HOMs and can be excited when a particle beam travels through the cavity. The main superconducting RF linac HOM-related issues are beam instabilities and the HOM-induced power [6], which increases the cryogenic heat load and may cause SRF cavity quenching. The HOM couplers are used to dampen the HOMs to prevent a resonant buildup of beam-induced fields by extracting the HOM-induced power from a cavity into room temperature loads.

There are three main kinds of HOM couplers used to remove HOM-induced power from a SRF cavity: the waveguide HOM coupler with dissipative loads

used in the CEBAF (Continuous Electron Beam Accelerator Facility) cavity at the Thomas Jefferson National Accelerator Facility (JLab), the fluted beam tube leading to ferrite dissipative loads used at the CESR (Cornell Electron-positron Storage Ring) cavity and a coaxial loop-type TTF HOM coupler using a notch filter to reject a fundamental mode [7]. Due to its smaller size, simpler structure, lower heat load for a cryogenic system and easy notch frequency tuning compared to the waveguide HOM coupler, the TTF HOM coupler is used in many multi-cell cavities, such as the TESLA cavities, the SNS (Spallation Neutron Source) cavities, the Low Loss cavities at the ILC (International Linear Collider), the High Gradient cavities at the ILC, the CEBAF upgrade cavities, etc.

Even though a TTF HOM coupler has been successfully used on many cavities, two faults were found during the VTA (Vertical Test Area) testing and the cryomodule testing for some SNS cavities at JLab, and the SNS commissioning at ORNL (Oak Ridge

---

Received 16 June 2010

1) E-mail: sun\_ancn@yahoo.com

©2011 Chinese Physical Society and the Institute of High Energy Physics of the Chinese Academy of Sciences and the Institute of Modern Physics of the Chinese Academy of Sciences and IOP Publishing Ltd

National Laboratory): notch frequency shift and melting of the capacitive coupling copper feed-through tip. These faults caused two SNS SRF cavities to become unpowered and ten SNS SRF cavities to operate at a reduced gradient [8–10]. JLab tried to change the copper feed-through into a niobium feed-through in a Renaissance Cryomodule. The test results were that a quenching happened instead of the tip melting.

A low-beta superconducting RF cavity ( $\beta_g=0.42$ ) is being considered in order to accelerate a proton beam at 700 MHz in the PEFP linac and its extended project [11–15]. HOM analysis of the PEFP low-beta cavities shows that the HOM coupler's external quality factor  $Q_{\text{ext}}$  is lower than  $3 \times 10^5$ , thus reducing the influence of dangerous modes on the beam instabilities and the HOM-induced power [16]. Table 1 lists the specifications of the PEFP HOM damping.

Table 1. HOM coupler specifications for the PEFP low-beta cavity.

parameter	value
HOM damping modes	M23, M31, M32, M33, D11, D32*
$Q_{\text{ext}}$ for HOM damping mode	$\leq 3 \times 10^5$
HOM average RF load	$\leq 1.0$ W
$Q_{\text{ext}}$ for TM <sub>010</sub> $\pi$ mode	$\geq 6.26 \times 10^{10}$
fundamental $\pi$ mode RF load at $E_{\text{acc}}=8$ MV/m (in a macro-pulse)	$\leq 10$ W

\*Here, 'Mm' and 'Dm' mean the  $m$ -th mode of the monopole and the dipole of the MAFIA calculation, respectively.

In order to satisfy the PEFP HOM damping requirements, and to avoid the shortcomings of the TTF HOM coupler, a new coaxial HOM coupler with one hook and two rods has been designed for the PEFP SRF cavities. This coupler can satisfy the HOM damping requirements of the PEFP SRF linac and has a good filter property, low electromagnetic fields at the inner conductor ends and it is easy to tune and control a notch frequency. In order to confirm the HOM coupler design and finalize the inner conductor penetration depth and angle between the cavity axis and the hook of the inner conductor, two prototype HOM couplers have been fabricated and tested with a copper prototype cavity. The testing and measurements of the HOM couplers have shown that the new HOM coupler can fully meet the damping requirements of the PEFP low-beta superconducting RF linac. Based on the test results, the final dimensions of the HOM couplers have been determined.

## 2 PEFP HOM coupler design

Figure 1 shows a TTF coaxial HOM coupler for the SNS cavities [8, 17]. The HOM-induced power is coupled out by a coupling capacitance, which is a gap of about 0.76 mm composed of a feed-through tip and a cutting flat face on the inner conductor. The 3-D simulation showed that there was a high electromagnetic field in the coupling capacitance gap. After high power measurements in the VTA at JLab, tip melting in some of the cavities was observed. Because the HOM coupler 2 is located opposite the fundamental power coupler (FPC), the melted tip could drop onto the FPC inner conductor or window, and create big bursts of gas in the FPC, which causes vacuum-related interlock trips. In addition, the melted tip could become welded to the inner conductor, this results in excessive fundamental power coupled through the HOM signal. These vacuum-related interlock trips and the excessive fundamental power coupled through the HOM signal were observed during SNS SCL commissioning. The excessive fundamental power coupling caused two SNS cavities to be unpowered [10].

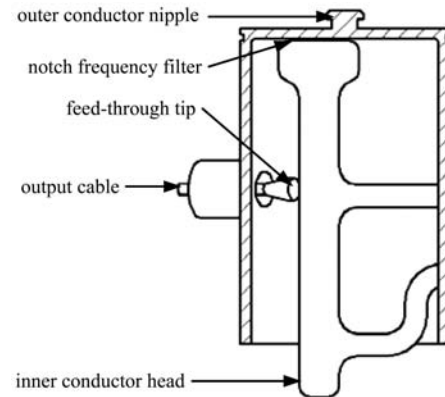

Fig. 1. SNS HOM coupler scheme.

The notch frequency is controlled by adjusting the notch frequency filter capacitance, which is a gap of about 0.53 mm between the inner conductor end and the outer conductor cover. For the SNS prototype cavities and the first medium-beta cryomodules, by pulling or pushing the nipple on the outer conductor to obtain a physical deformation and to setup notch frequency, after cooling down the cryomodules, due to thermal shrinkage of the outer conductor, the physical deformation was lost. Finally, the notch frequency shifted for some HOM couplers. From the second medium-beta cryomodules, a one-direction locker was used to fix the notch frequency by holding the nipple, the results were that the notch frequency of

some HOM couplers was fixed, but some HOM couplers had shifted. This notch frequency shift results in abnormal fundamental frequency signals being transmitted through the HOM couplers, which was observed during cryomodule testing in the test cave at JLab, and also in the SNS tunnel during the SCL commissioning, and caused 10 SNS cavities to operate at reduced gradients and/or repetition rates [10].

In order to avoid the same disasters in the PEFP HOM couplers, a new type of coaxial HOM coupler needs to be designed for the PEFP cavities. The new coupler should meet the PEFP HOM damping requirements, the notch frequency shift should be easily controlled and melting of the feed-through tip should be eradicated.

## 2.1 HOM coupler structure

The PEFP HOM coupler design is based on the TTF type coaxial HOM coupler, as shown in Fig. 2. The feed-through for coupling out the HOM induced power is directly installed on the inner conductor in order to avoid the feed-through tip melting, as observed in the SNS HOM couplers. Two stubs are used to adjust the notch frequency and to optimize the electro-magnetic distribution during the coupler 3-D design. The rod of the inner conductor is used to couple the electric components of the HOMs and the hook of the inner conductor is used to couple the magnetic components of the HOMs.

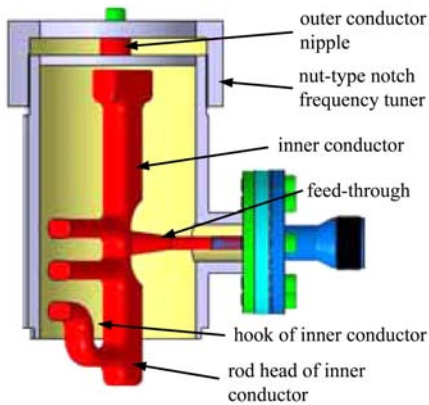

Fig. 2. A cutaway of a 3-D PEFP HOM coupler.

Based on the tuning and operating experiences of the SNS HOM couplers, a nut-type notch frequency tuner was designed for the PEFP HOM couplers. The tuner holds the nipple on the outer conductor of the HOM coupler. By screwing the nut-tuner, the gap of the notch frequency filter capacitance is changed causing the the notch frequency filter capacitance to be changed. Because the nut can be screwed in two

directions, this tuner can tune the notch frequency in both directions.

The outer conductor, the inner conductor and the feed-through are made of a high RRR niobium (Nb). Because NbTi alloy has almost the same thermal properties as Nb, but has better mechanical properties than pure Nb, we chose NbTi alloy to fabricate the notch frequency tuner and the flange of the feed-through of the coupler.

## 2.2 HOM coupler optimization

The basic rules to optimize the coaxial HOM coupler are:

- The notch frequency is the cavity operating frequency.
- The notch of the operating frequency should be as deep as possible.
- Filter notch frequency sensitivity should be as low as possible.
- There should be a uniform electric field or magnetic field in the coupler.
- Notch frequency can be easily tuned and controlled.

Normally we use an out-coupled power with dB to evaluate the filter properties of a HOM coupler. Based on the above rules, we simulated the out-coupled power for different angles between two rods, and for different distances between two rods, between the up-rod and the filter end, between the down-rod and the inner conductor head, and for different hook shapes, as well as for various outer conductor diameters and inner conductor positions and diameters by using a 3-D MicroWave Studio (MWS)[18]. According to the simulation results of the out-coupled power

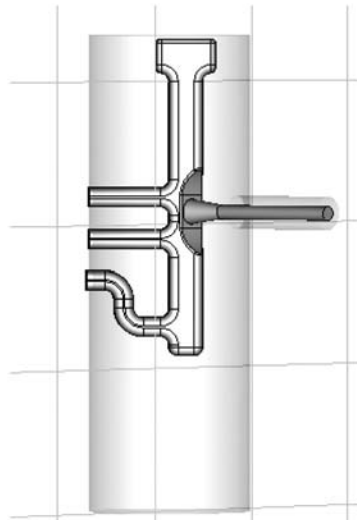

Fig. 3. A MWS mode of a PEFP HOM coupler.

and by considering the cavity space for the HOM coupler installation and HOM coupler fabrication difficulty, we finalized an optimized HOM coupler structure simulation, as shown in Fig. 3. The filter notch sensitivity of the PEFP coupler is 105 MHz/mm, which is 46% lower than that of 226 MHz/mm found in the SNS HOM couplers.

Figure 4 shows the out-coupled power curves of the PEFP and SNS HOM couplers. Fig. 4 reveals that the PEFP HOM coupler has only one deepest notch and the same out-coupled power as that of the SNS HOM coupler.

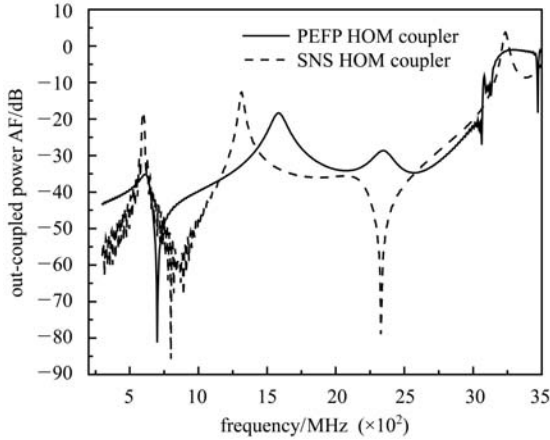

Fig. 4. Out-coupled power comparison between a PEFP HOM coupler and an SNS HOM coupler.

Unsuitable strong electromagnetic (EM) field distribution of the  $TM_{010}$   $\pi$  mode in a HOM coupler could induce strong electric field emission from the inner conductor surface, multipacting in the coupler and an electron load in the capacitive gaps that could

cause SRF cavity quenching or unpowered cavities, such as found with the SNS HOM couplers. Therefore, we need concentrate on reducing the EM field on the inner and outer conductors' surface during their design. A 3-D MWS cavity with two HOM couplers, a fundamental power coupler (FPC) and a field probe were used to simulate the EM field distribution in the cavity and in the couplers. In the simulation, two HOM couplers were installed on a PEFP SRF cavity with a relative azimuthal angle of about  $90^\circ$  to ensure damping of both polarizations of the dipole modes. One coupler was attached to each end of the cavity, as shown in Fig. 5.

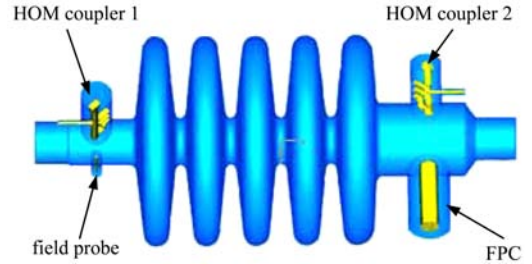

Fig. 5. A 3-D MWS mode of a PEFP low-beta cavity with two HOM couplers, an FPC and a field probe.

Table 2 lists the simulation results of the maximum EM fields on the cavity surface, on the FPC head and on different parts of the HOM couplers of a PEFP SRF low-beta cavity and an SNS medium-beta cavity. The results show that the maximum EM fields in the PEFP HOM coupler are approximately one tenth that of the fields in the SNS medium-beta cavity at the same peak surface electric field on the cavities.

Table 2. The electromagnetic fields in the SNS HOM coupler and the PEFP HOM coupler at the same cavity surface peak electric field.

position	SNS		PEFP	
	$E/(V/m)$	$H/(A/m)$	$E/(V/m)$	$H/(A/m)$
cavity surface	$1.00 \times 10^7$	$1.85 \times 10^4$	$1.00 \times 10^7$	$1.51 \times 10^4$
FPC head	$8.65 \times 10^5$	697	$4.54 \times 10^5$	946
HOM coupler inner conductor head	$3.29 \times 10^6$	1863	$5.30 \times 10^5$	575
HOM coupler inner conductor top	$1.25 \times 10^6$	0	$9.93 \times 10^4$	0
HOM coupler feed-through tip	$5.81 \times 10^4$	1128	N/A	N/A

### 3 Prototype HOM coupler

After HOM analysis of the PEFP low-beta cavities, specifications for the PEFP HOM couplers were obtained [15]. In order to confirm the HOM coupler design, to finalize its inner conductor penetra-

tion depth and its angle between the cavity axis and the hook of the inner conductor, and to analyze the PEFP HOM damping results, two prototype HOM couplers were fabricated. A copper prototype cavity with two HOM ports with a relative azimuthal angle of about  $90^\circ$  was fabricated, and tuned to produce a

field flatness of 1.43% at 700 MHz [19].

Figure 6 shows the HOM coupler prototype. A flange with three 60° circular slotted holes on the HOM coupler body is for changing the angle between the coupler hook and the beam axis. Each HOM port on a cavity beam pipe has a flange with 24 screw holes that can make a hook angle change with 15° steps. Two types of washers with three 60° circular slotted

holes with a thickness of 0.1 mm and 1.0 mm were inserted between a coupler flange and a HOM port flange, as shown in Fig. 7. By varying the washer number, the penetration of an inner conductor of the HOM coupler is varied. By changing the relative angle between the HOM coupler flange and the HOM port flange on a cavity beam-pipe, the angle between the hook and the beam axis can be varied.

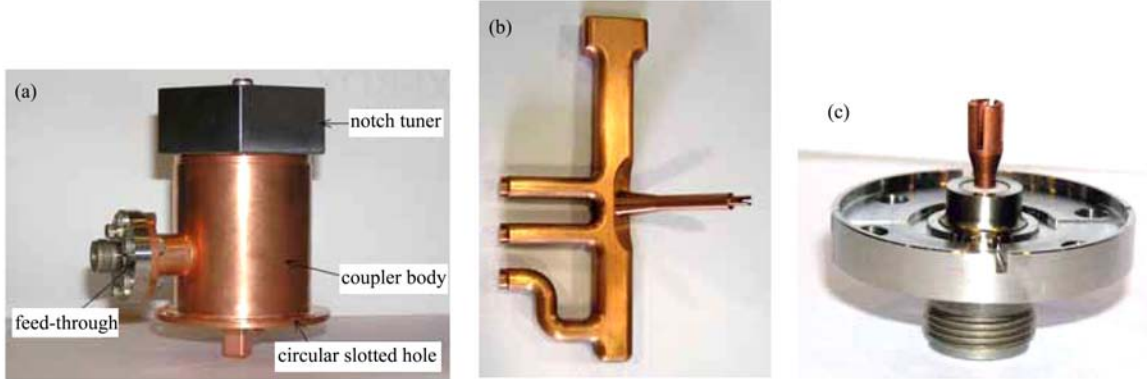

Fig. 6. A PEFP prototype HOM coupler. (a) the prototype HOM coupler; (b) the inner conductor and feed-through; (c) the vacuum feed-through.

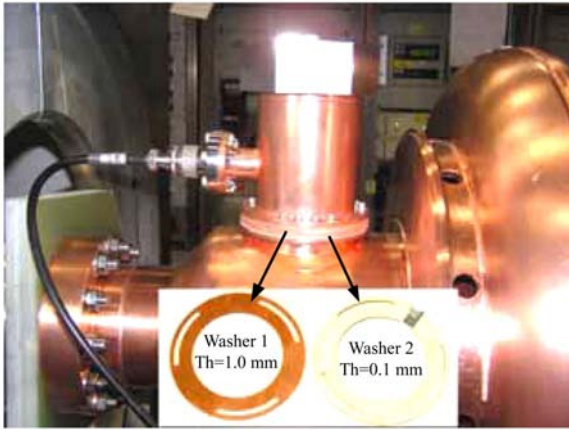

Fig. 7. An assembly of the HOM coupler, washers and cavity on the FPC side.

#### 4 Measurements of the HOM couplers' characteristics

Figure 8 shows a setup to measure the  $Q_{\text{ext}}$  of the HOM couplers. Two HOM couplers were installed on the prototype cavity with washers. We used a network analyzer to measure the cavity-loaded quality factor  $Q_L$  and the reflected coefficients S11 and S22 of HOM couplers 1 and 2, and we used a Smith chart to distinguish if the coupler was over-coupled or under-

coupled [20]. Then we obtained the coupling coefficients of the couplers using the following equations:

$$\beta_{e1} = \frac{1+S11}{1-S11} \text{ (for over-coupled)}$$

or

$$\beta_{e1} = \frac{1-S11}{1+S11} \text{ (for under-coupler),}$$

and

$$\beta_{e2} = \frac{1+S22}{1-S22} \text{ (for over-coupled)}$$

or

$$\beta_{e2} = \frac{1-S22}{1+S22} \text{ (for under-coupled).}$$

Here  $\beta_{e1}$  and  $\beta_{e2}$  are the coupling coefficients of couplers 1 and 2, respectively. Then we had an intrinsic quality factor  $Q_0$  of the cavity:

$$Q_0 = Q_L(1 + \beta_{e1} + \beta_{e2}).$$

The external quality factors of the couplers are:

$$Q_{\text{ext}1} = Q_0/\beta_{e1} \quad \text{and} \quad Q_{\text{ext}2} = Q_0/\beta_{e2}.$$

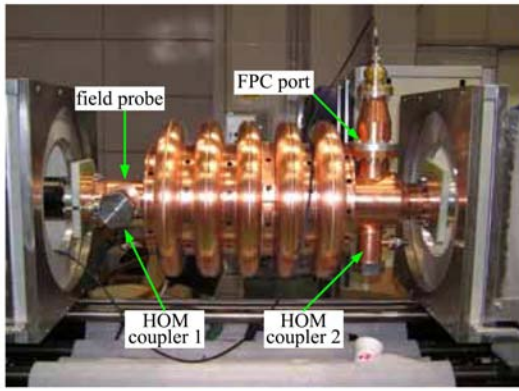

Fig. 8. External quality factor  $Q_e$  measurement setup of HOM coupler 1.

#### 4.1 Measurements of the filter characteristics

Measurements of the HOM coupler's filter characteristics include the filter properties of the HOM spectrum and that of the TM010  $\pi$  mode. Due to fabrication errors, the original notch frequency was not at 700 MHz. For example, the notch frequency of HOM coupler 1 (field probe side) was 718.723 MHz, and that of HOM coupler 2 (FPC side) was 768.598 MHz. By using the notch frequency tuner, we tuned the notch frequency to 700 MHz. The cross-talk method was used to measure the notch shift and filter properties for the HOM spectrum, specifically, when measuring the filter property of HOM coupler 1 (or 2), we input the scanning frequency signal from a Field Probe (or FPC) and collected the transmission signal from HOM coupler 1 (or 2). The test results reveal that the HOM couplers' filter properties are almost the same as in the simulation design.

We used S21 and S11 to measure the HOM coupler filter properties for the TM010  $\pi$  mode, namely the  $Q_{\text{ext}}$  at 700 MHz. The specification for the filter

for the TM010  $\pi$  mode in Table 1 is:  $Q_{\text{ext}} \geq 6.26 \times 10^{10}$ . The tested results are: for HOM coupler 1, its  $Q_{\text{ext}} = 9.16 \times 10^{12}$ ; for HOM coupler 2, its  $Q_{\text{ext}} = 1.59 \times 10^{11}$ . This means that our new HOM coupler can meet our filter requirements.

#### 4.2 Hook angle and penetration testing

By changing the hook angle, we obtained a curve of the HOM couplers'  $Q_{\text{ext}}$  versus the angle between the hook and the beam-axis. Fig. 9 shows the  $Q_{\text{ext}}$  versus the hook angle of HOM coupler 1 for HOM M23, D11, D32 and Q14. Here, Q14A, Q14B, Q14C and Q14D are the four components of quadrupole 14. Because Q14C can only be measured for several angles, we did not plot its curve here. According to the test results and the theoretical analysis, and by considering the final HOM coupler feed-through assembly,  $45^\circ$  was chosen as the final angle.

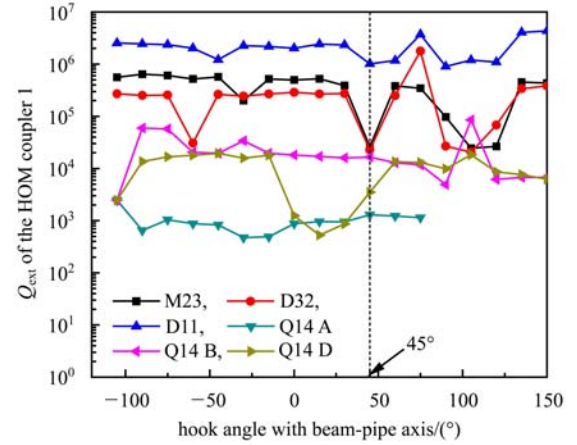

Fig. 9. External quality factor  $Q_{\text{ext}}$  of HOM coupler 1 for different hook angles with the cavity axis.

Table 3. Measurement results of the PEFP HOM coupler damping for dangerous HOMs.

HOM	frequency/MHz from FPC to FP	$Q_L$ value with HOM couplers	$Q_L$ value without HOM couplers	$R$ value with HOM couplers*	$R$ value without HOM couplers*
dipole 11	1743.783	No -3dB	$5.03 \times 10^6$		$1.36 \text{ M}\Omega/\text{cm}^2$
	1745.611	$3.57 \times 10^2$	$7.55 \times 10^6$	$96.8 \text{ }\Omega/\text{cm}^2$	$2.05 \text{ M}\Omega/\text{cm}^2$
quadrupole 14	2446.8	$7.19 \times 10^2$	$2.21 \times 10^4$	$0.092 \text{ }\Omega/\text{cm}^4$	$2.83 \text{ }\Omega/\text{cm}^4$
	2450.648	$1.17 \times 10^3$	$2.58 \times 10^4$	$0.15 \text{ }\Omega/\text{cm}^4$	$3.30 \text{ }\Omega/\text{cm}^4$
	2453.73	$1.52 \times 10^3$	$7.18 \times 10^4$	$0.194 \text{ }\Omega/\text{cm}^4$	$9.19 \text{ }\Omega/\text{cm}^4$
	2456.976	$1.36 \times 10^5$	$1.50 \times 10^5$	$17.4 \text{ }\Omega/\text{cm}^4$	$19.2 \text{ }\Omega/\text{cm}^4$
monopole23	2769.363	$1.57 \times 10^3$	$1.36 \times 10^4$	$82.5 \text{ }\Omega$	$715 \text{ }\Omega$
dipole 32	2817.555	$3.58 \times 10^3$	$3.09 \times 10^4$	$100 \text{ }\Omega/\text{cm}^2$	$863 \text{ }\Omega/\text{cm}^2$
	2818.304	No -3dB	$2.64 \times 10^4$		$737 \text{ }\Omega/\text{cm}^2$

\* Here the impedance  $R$ 's for the multipoles are evaluated at the position of 1 cm from the axis and their units are  $\Omega/\text{cm}^2$  and  $\Omega/\text{cm}^4$  for dipoles and quadrupoles, respectively.

By changing the washer number, the inner conductor penetration of the PEFP prototype HOM coupler was changed. According to the measured results and by considering the fundamental power leak and the effects of the inner conductor on the beam, the final washer thickness was chosen as 5.32 mm for both of the HOM couplers.

### 4.3 HOM damping measurements

After fixing the HOM coupler's hook angle and inner conductor penetration depth, we measured the  $Q_{\text{ext}}$  of the HOM couplers. The HOM damping specification is that a HOM coupler's  $Q_{\text{ext}} \leq 3 \times 10^5$  for the HOMs. If there are no HOM couplers, the HOM is damped by the fundamental power coupler and field probe. Table 3 lists the HOM's  $Q_L$  (supposing  $Q_0 \sim 10^9$ ) and impedance with and without HOM couplers for dangerous and potentially dangerous HOMs. We find that the new HOM coupler can damp the HOMs efficiently. The measurement results show that the new HOM couplers can fully meet the PEFP HOM damping requirements.

## 5 Conclusion

A new type of coaxial HOM coupler with one hook and two stubs has been designed for PEFP SRF cavities. This HOM coupler is able to overcome the notch frequency shift and feed-through tip melting issues found in the SNS HOM coupler. The 3-D simulation shows that this coupler has a good filter property and low electromagnetic fields on the inner conductor ends. The low-power testing and measurements of the prototype HOM couplers have demonstrated that this coupler is easy to tune and control in regard its notch frequency, and can fully meet the damping requirements of the PEFP low-beta superconducting RF linac.

*The authors would thank P. Kneisel and H. Wang from JLab for the essential discussions during their design. This work is supported by the Ministry of Education, Science and Technology of the Korean Government.*

## References

- 1 Alonso J R. Rev. Sci. Instrum., 1996, **67**: 1308
- 2 SUN An, Joo Y D, Kang H S. J. Korean Phys. Soc., 2010, **56**: 2024
- 3 Gebel R, Felden O, Von Rossen P. Rev. Sci. Instrum., 2004, **75**: 1860
- 4 Kim J W, Goto A, Yano Y. Rev. Sci. Instrum., 1999, **70**: 2293
- 5 Benaroya R, Shepard K W. Rev. Sci. Instrum., 1988, **59**: 2100
- 6 Kim S H, Doleans M, Jeon D O, Sundelin R. Nucl. Instrum. Methods A, 2002, **492**: 1
- 7 Padamsee H, Knobloch J, Hays T. RF Superconductivity for Accelerators. New York: John Wiley & Sons, 1998. 335
- 8 Kim S H et al. Study on Fault Scenarios of Coaxial Type HOM Couplers in SRF Cavities. In: Proceedings of LINAC 2006. Knoxville, USA: JACoW, 2006. 770
- 9 Kim S H J. Korean Phys. Soc., 2008, **52**: 714
- 10 Henderson S. Commissioning and Initial Operating Experience with the SNS 1-GeV Linac. In: Proceedings of LINAC 2006. Knoxville, USA: JACoW, 2006. 1
- 11 ZHANG Li-Ping, SUN An, LI Yin-Min, TANG Ya-Zhe, Cho Y S. J. Korean Phys. Soc., 2009, **54**: 2025
- 12 SUN An, ZHANG Li-Ping, TANG Ya-Zhe, LI Ying-Min, GAO Chang-Yi, Cho Y S. PEFP Dumbbell Frequency and Length tuning of a Low-beta SRF Cavity. In: Proceedings of EPAC 2008. Genoa, Italy: JACoW, 2008. 823
- 13 SUN An, Kim H S, Cho Y S, Choi B H. J. Korean Phys. Soc., 2008, **52**: 793
- 14 SUN An, Cho Y S, Choi B H. Design of the PEFP Low Beta Cryomodule. In: Proceedings of APAC 2007. Indore, India: JACoW, 2007. 564
- 15 SUN An, ZHANG Li-Ping, TANG Ya-Zhe, LI Ying-Min, Cho Y S. Rev. Sci. Instrum., 2008, **79**: 104701
- 16 SUN An, Cho Y S, Choi B H, Jang J H. J. Korean Phys. Soc., 2007, **50**: 1421
- 17 Ciovati G et al. Superconducting Prototype Cavities for the Spallation Neutron Source (SNS) Project. In: Proceedings of PAC 2001. Chicago: JACoW, 2001. 484
- 18 CST MICROWAVE STUDIO Version 5 Getting Started, Nov. 2003. CST-Computer Simulation Technology
- 19 SUN An, ZHANG Li-Ping, TANG Ya-Zhe, LI Ying-Min, GAO Chang-Yi, Cho Y S, Choi B H. PEFP Dumbbell Frequency and Length Tuning of a Low-beta SRF Cavity. In: Proceedings of EPAC 2008. Genoa, Italy: JACoW, 2008. 820
- 20 Pozar D. Microwave Engineering (Second edition). New York: John Wiley & Sons, 1998. 333