

Study of a bulk-Micromegas with a resistive anode^{*}

FAN Sheng-Nan(范胜男)^{1,2,3;1)} FAN Rui-Rui(樊瑞睿)¹ WANG Bo(王波)¹
 QI Hui-Rong(祁辉荣)^{1,3;2)} OUYANG Qun(欧阳群)^{1,3} YI Fu-Ting(伊福廷)¹
 ZHAO Tian-Chi(赵天池)⁴ CHEN Yuan-Bo(陈元柏)^{1,3} LIU Mei(刘梅)^{1,2,3}
 LIU Rong-Guang(刘荣光)^{1,3} ZHANG Jian(张建)^{1,3}

¹ Institute of High Energy Physics, Chinese Academy of Sciences, Beijing 100049, China

² Graduate University of Chinese Academy of Sciences, Beijing 100049, China

³ State Key Laboratory of Particle Detection and Electronics, Beijing 100049, China

⁴ Department of Physics, University of Washington, Seattle, WA98195, USA

Abstract: The design and performance of a Micromegas with a resistive anode are presented in this paper. A thin resistive sheet with volume resistivity of $10^{12} \Omega \cdot \text{cm}$ is glued onto the readout electrode surface and its performance is investigated by using a ^{55}Fe X-ray radioactive source in the operation gas of argon and isobutene mixtures (Ar/Iso=95/5). The gas gain at different mesh high voltage, counting rate and working time are given. Energy spectra at different working voltages are measured and the results are discussed. We have observed that a Micromegas with a resistive anode can be operated at higher gain than a standard Micromegas without sparks.

Key words: Micromegas, resistive anode, sparks, gas gain

PACS: 29.40.Cs **DOI:** 10.1088/1674-1137/36/9/010

1 Introduction

The Micromegas, as a new type of gaseous detector, was invented in 1996 [1]. The structure of a standard Micromegas is shown in Fig. 1 and it consists of three electrodes: drift electrode, avalanche electrode and anode. The avalanche electrode is made of metallic micromesh and the anode is the copper strips or pads on a glass fiber reinforced epoxy substrate. The gap between the drift electrode and avalanche electrode is the conversion region and, the gap between the micromesh and the anode is the avalanche region. In the conversion region, electron-ion pairs are produced by ionization in the working gas. Electrons are drifted through the micromesh into the amplification gap following electric force lines, where they are multiplied in an avalanche process. The distance between the avalanche electrode and anode is maintained accurately by the array of tiny pillars using the “Bulk” technology that was developed by Saclay-CERN col-

laboration in 2006 [2].

The bulk-Micromegas has been used in particle physics experiments in the last several years with the good properties of high rate capability, high radiation resistivity, excellent position and energy resolution. The limitation of the Micromegas is that it is vulnerable to sparks, especially in a high radiation environment. If large numbers of electron-ion pairs are produced by avalanches in the amplification gap, they could lead to discharge between the mesh and the metal readout anode. Discharges will occur when the total number of generated electrons in the amplification region exceeds approximately 10^7 (Raether limit [3]). Additionally, in very high particle flux, the Micromegas is vulnerable to sparks because avalanches can so easily overlap with each other in space and time [4] that the density of local electrons may be much bigger. In the extreme cases, sparks may also damage the detector and electronics.

A method could reduce the sparks between the

Received 14 September 2011, Revised 17 April 2012

* Supported by NSFC (10775156)

1) E-mail: fansn@ihep.ac.cn

2) E-mail: qihr@ihep.ac.cn

©2012 Chinese Physical Society and the Institute of High Energy Physics of the Chinese Academy of Sciences and the Institute of Modern Physics of the Chinese Academy of Sciences and IOP Publishing Ltd

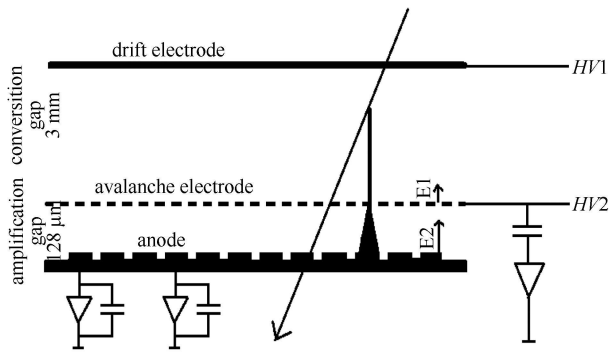

Fig. 1. The structure of a standard Micromegas.

mesh and the readout electrode by adding a resistive layer on the anode surface [5]. The resistive layer with appropriate resistivity can make signals induced on the readout strips or pad wider, which allows the usage of wider readout elements in precision tracking [6, 7]. In this paper, we selected the SD-A resistive film for our prototype study of the bulk-Micromegas detector with a resistive anode. The results show that a resistive anode can reduce sparks and the detector can be operated at higher gain.

2 Spark-resistant bulk-Micromegas

2.1 The detector design

The plastic sheet SD-A Pomalux[®] film [8] is glued onto the readout electrode surface and its thickness is 250 μm . In room-temperature and dry air, the volume resistivity of the SD-A Pomalux[®] film is measured to be approximately $10^{12} \Omega \cdot \text{cm}$ after going through the heating process that is necessary for making the bulk-Micromegas. Unlike many other polymers developed for industrial anti-static applications, this material is non-carbon-filled and its conductivity is permanent. Between the printed circuit boards (PCB) and the SD-A film, the carbon loaded paper with the volume resistivity of $10^7\text{--}10^8 \Omega \cdot \text{cm}$ is used as the adhesive layer. The SD-A Pomalux[®]

film and the adhesive layer are tightly glued together with a total thickness of 550 μm and are firmly attached to the PCB surfaces. The construction of the bulk-Micromegas with SD-A Pomalux[®] is shown in Fig. 2. In the design of the detector, the amplification gap is obtained by suspending a mesh over the surface of the anode pads. The quite narrow gap, which is 128 μm , is formed by using array tiny pillars printed on top of the anode plane by conventional lithography of a photoresistive film. The mesh that we used is a woven mesh made of the stainless-steel wires of 22 μm in diameter and the pitch is 62 μm . To obtain good flatness and improve the transmittance of electrons, the mesh is stretched by a stainless steel device to a tension of 27N. The assembled detector has an active area of 30 mm \times 30 mm and the same size drift electrode is also made of stainless-steel woven mesh.

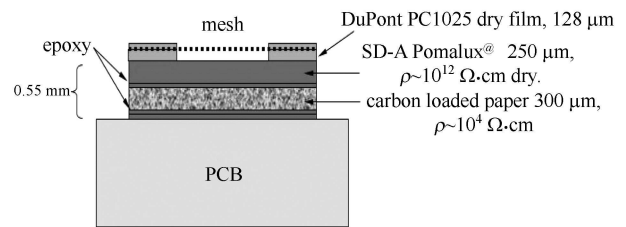

Fig. 2. Sketch of the bulk-Micromegas with a resistive anode.

2.2 Experimental schemes

In our test, a gas mixture of argon and isobutene (Ar/Iso=95/5) is used as the usual selection working gas for the bulk-Micromegas detector. The flow of working gas is controlled by the gas flow meter. From our test, the gas leakage rate of the chamber is less than 0.1 mL/h. The high voltages to the electrodes are individually supplied by CAEN SY127 and the current of the avalanche electrode is monitored. To test the detector, a ^{55}Fe X-ray source with a lead collimator of 1 mm diameter hole is placed 2 mm away from the window of the chamber, which

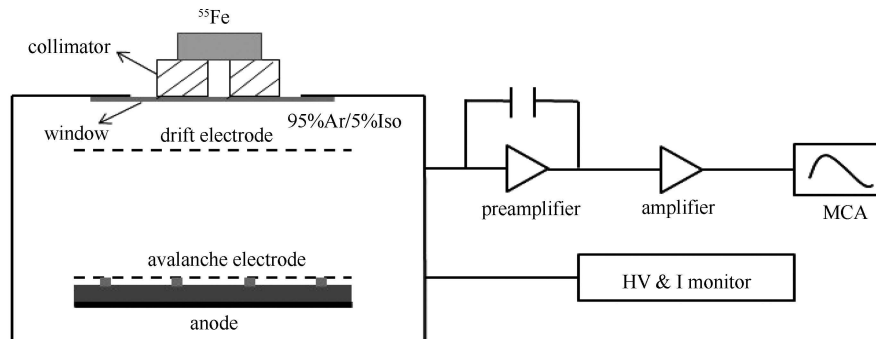

Fig. 3. The experimental scheme of the Micromegas detector.

is made of a thin mylar film. Fig. 3 shows the details of the experimental setup. The signal collected by the avalanche electrode is sent to a charge sensitive preamplifier(Ortec 142IH), and then shaped and amplified by Ortec 572A. The output signal of the amplifier is acquired and analyzed by a multi-channel analyzer (Ortec ASPEC 927).

3 The experimental results and discussions

3.1 The gain of the bulk-Micromegas

The gas gains as a function of micro-mesh high voltage for the standard and the resistive Micromegas chambers are given in Fig. 4. The gas gain of the spark-resistant Micromegas can reach 2×10^5 at $HV_2 = 510$ V, while the maximum gain of the standard Micromegas without a resistive layer can only reach 10^4 at $HV_2 = 420$ V before serious sparks start to occur. It shows the resistive layer glued on the anode surface is able to suppress sparks and increase the operation gain because the resistive sheet can effectively quench the avalanches and suppress the discharges. Compared with the standard Micromegas, the gas gain of the resistant Micromegas is lower at the same working high voltage. When the gain is above 2×10^5 , the saturation of gas gain for the spark-resistant Micromegas will appear (as shown in Fig. 4) and the gain does not increase any more in the range of 550 V to 650 V. The reason is that the recharging of the resistive surface has a time constant:

$$\tau = \varepsilon_r \varepsilon_0 \rho_v,$$

where ε_0 is the vacuum permittivity, ε_r is the dielectric constant and ρ_v is the volume resistivity of

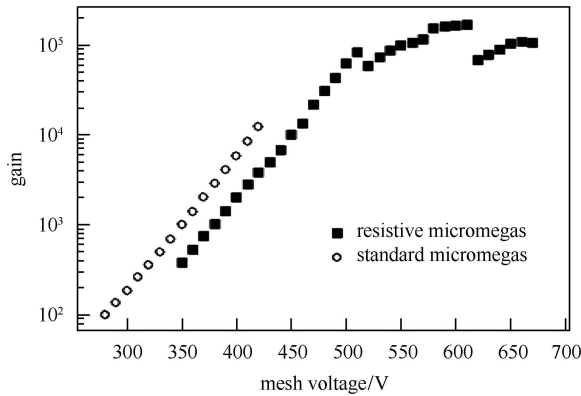

Fig. 4. The gains of standard and resistive Micromegas chambers.

the resistive layer [9]. According to $\varepsilon_r \approx 5$, $\varepsilon_0 = 8.85 \times 10^{-12} \text{ F} \cdot \text{m}^{-1}$ and $\rho_v \approx 10^{12} \Omega \cdot \text{cm}$, so $\tau \approx 0.5$ s. The recharging time is so long that the charge cannot disperse quickly.

By changing the size of hole in the lead collimator for the X-ray radioactive source, the gas gains at different counting rates are measured. The result is given in Fig. 5 and the data is obtained at 50 Hz and 10 Hz respectively. At the counting rate of 10 Hz, the gas gain is higher at the same high voltage and could get higher gain without the saturation effect compared with the situation at 50 Hz. The charge cluster on the resistive anode would disperse seriously at 50 Hz when the high voltage of mesh exceeds 500 V, and then the saturation effect of gain is obvious. It shows that the Micromegas detector should use the resistive anode to protect it if the higher gain is obtained without sparks. Simultaneously the resistive anode should be optimized at different counting rates to avoid the saturation effect. The diffusion range of charge in the resistive anode will be further studied in another paper.

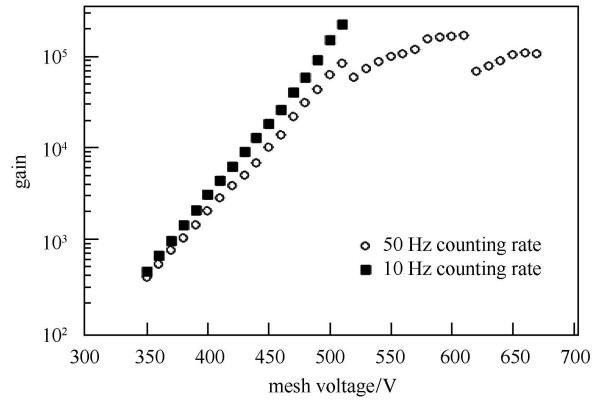

Fig. 5. The gas gain at different counting rates.

3.2 ^{55}Fe spectra and energy resolution

Figure 6 shows the results of ^{55}Fe energy spectra at different working high voltages of mesh in linear scale while the operating gas is Ar/Iso(95/5). The FWHMs of the full energy peaks are 27.69%, 29.88% and 51.63% corresponding to the gain of 1800, $\sim 10^4$ and $\sim 10^5$ respectively. The energy resolution is calculated by the following formula

$$\eta = \omega / \rho = 2.35\sigma / \rho,$$

where ω is the full width at half maximum(FWHM) and ρ is the mean value of the energy spectrum by Gaussian fitting.

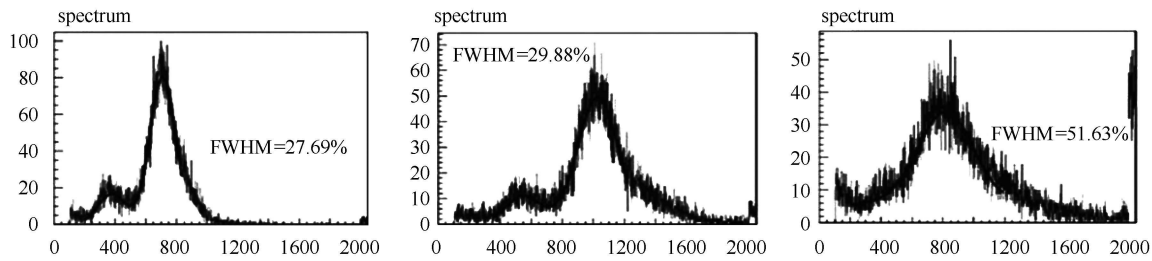

Fig. 6. The ^{55}Fe energy spectra at different working voltage.

In our results, the best value of ω is 27.69%, which is worse than that of the standard bulk-Micromegas (about 16% [10]). One possible reason is that the electrons do not disperse rapidly because of the anode's high resistivity. In the fabrication process, the resistive layer's thickness is not uniform and it would lead to the electric field's change in the amplification gap. In the test of the resistant bulk-Micromegas, the discharge rate will rise while the gain increases over 10^5 and the energy resolution becomes worse. Therefore, we need to find a new resistive material

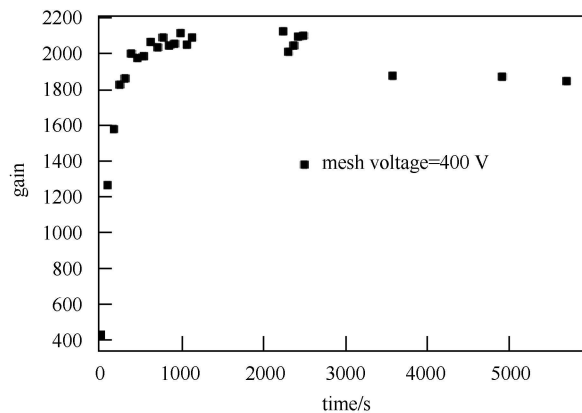

Fig. 7. The gas gain changes with time.

with appropriate resistivity and improved technology to use to add the resistive layer onto the anode surface.

The gas gain of the detector changes with the working time because of the effect charging-up in the resistive anode. The data of two continuous hours after the detector is turned on are shown in Fig. 7. At the beginning, the gas gain rises sharply with time, and then it changes slowly and tends to stabilize after 90 minutes. All the results of gains mentioned in this paper are obtained when they are stable.

4 Conclusion

The performance of the resistive Micromegas with the SD-A Pomalux[®] film as a resistive coating and carbon loaded paper as an adhesive layer is studied. The effective gain of the detector can reach more than 10^5 without significant spark remaining stable after 90 minutes of the working time. It indicates that the resistive anode could significantly reduce the discharge. Unfortunately, the resistivity of SD-A film can not be accurately controlled in the fabrication process. For further improvement, the other options of the resistive anode will be studied.

References

- 1 Giomataris Y et al. Nucl. Instrum. Methods A, 1996, **376**: 29
- 2 Giomataris Y et al. Nucl. Instrum. Methods A, 2006, **560**: 405
- 3 Raether H. Z. Phys. A, 1939, **112**: 464
- 4 Fonte P et al. Nucl. Instrum. Methods A, 1991, **310**: 128
- 5 Fonte P et al. Nucl. Instrum. Methods A, 1999, **431**: 154
- 6 Dixit M et al. Nucl. Instrum. Methods A, 2007, **581**: 254
- 7 Desauvais P, Jeanjean J, Puill V. Performance of a New Type of Micromegas Detector with Stainless Steel Woven Wire Mesh and Resistive Anode Readout. In: 2003 Nuclear Science Symposium and Medical Imaging Conference Including Symposium on Nuclear Power Systems and 13TH International Workshop on Room Temperature Semiconductor X-and gamma-ray Detectors. Oregon, USA: World Scientific, 2003. 636
- 8 <http://westlakeplastics.com/pdf/PB%20static%20control%20pomalux.pdf>
- 9 Riegler W et al. Nucl. Instrum. Methods A, 2004, **469**: 287
- 10 FAN Rui-Rui et al. Chinese Physics C (HEP&NP), 2010, **34**(10): 1636