

Mismatch study of C-ADS main linac*

MENG Cai(孟才)¹⁾ TANG Jing-Yu(唐靖宇) PEI Shi-Lun(裴士伦) YAN Fang(闫芳)

Key Laboratory of Particle Acceleration Physics & Technology, Institute of High Energy Physics, Chinese Academy of Sciences, Beijing 100049, China

Abstract: The ADS accelerator in China is a Continuous-Wave (CW) proton linac with 1.5 GeV beam energy, 10 mA beam current, and 15 MW beam power. To meet the extremely low beam loss rate and high reliability requirements, it is very important to study the beam halo caused by beam mismatch, which is one major sources of beam loss. To avoid envelope instability, the phase advances per period are all smaller than 90 degrees in the main linac design. In this paper, simulation results of the emittance growth and the envelope oscillations caused by mismatch in the main linac section are presented. To meet the emittance growth requirement, the transverse and longitudinal mismatch factors should be smaller than 0.4 and 0.3, respectively.

Key words: mismatch, C-ADS accelerator, emittance, beam loss

PACS: 29.27.Bd, 29.27.Fh **DOI:** 10.1088/1674-1137/39/9/097002

1 Introduction

The ADS accelerator in China (C-ADS) is required to deliver a CW (Continuous-Wave) proton beam of energy 1.5 GeV and current 10 mA [1]. It is composed of two major accelerating parts: the injector and the main linac. The main linac is designed to boost the beam energy from 10 MeV up to 1.5 GeV with four accelerating sections, whose lattice structures are shown in Fig. 1. Solenoid focusing is applied in the two spoke cavity accelerating sections and triplet focusing is used in the two

elliptical cavity accelerating sections.

A beam loss rate of 1 W/m is typical for high-power proton accelerators, which is the radioprotection requirement for hands-on maintenance. To meet the extremely high reliability and availability required for the C-ADS accelerator, it is imperative to study the beam loss mechanisms. Beam halo caused by mismatch is one major source of beam loss, where the halo particle can be lost on the walls of the beamline structures. The impacts of misalignment errors and field errors are also very important and have been previously studied [2].

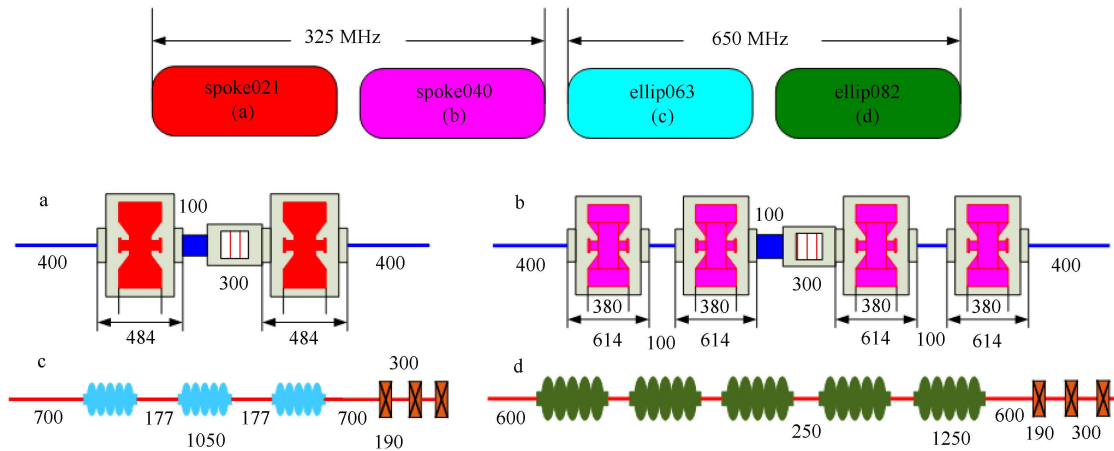

Fig. 1. (color online) Schematic view of the lattice structures for the main linac sections.

Received 1 December 2014, Revised 27 March 2015

* Supported by China ADS Project (XDA03020000) and National Natural Science Foundation of China (11235012)

1) E-mail: mengc@ihep.ac.cn

©2015 Chinese Physical Society and the Institute of High Energy Physics of the Chinese Academy of Sciences and the Institute of Modern Physics of the Chinese Academy of Sciences and IOP Publishing Ltd

The emittance growth due to mismatch should be carefully considered in the ADS accelerator where the beam loss is concerned. With the presence of nonlinear components, the filamentation effect will lead to a real emittance dilution, and the betatron modulation has a similar impact. More than filamentation, a mismatched beam can be unstable if the channel working point is not properly set. Some mismatched modes can exhibit an instability when the phase advance without space charge per focusing period is greater than 90° and the tune depression is low [3]. In this paper, simulation results of the ADS main linac with beam mismatch are presented.

2 Mismatch

If the ellipse in phase space of an injected beam is not matched to the downstream focusing system, then there will be additional oscillations of the rms beam envelopes. This produces a larger sized beam at some locations and a smaller sized beam at other locations. In this scenario, it is convenient to define a mismatch factor, which is a measure of the increase in the maximum beam size that results from a mismatch. Suppose that the matched beam phase space ellipse is defined by

$$\gamma_m x^2 + 2\alpha_m x x' + \beta_m x'^2 = \varepsilon$$

and a mismatched beam phase space ellipse with same area is defined by

$$\gamma x^2 + 2\alpha x x' + \beta x'^2 = \varepsilon,$$

where α_m , β_m , γ_m , α , β , γ are Twiss parameters and ε_m , ε are emittances of matched beam and mismatched beam.

Then the mismatch factor can be expressed as

$$M = \sqrt{\frac{\Delta + \sqrt{\Delta^2 - 4}}{2}} - 1, \quad (1)$$

where $\Delta = \beta_m \gamma + \gamma_m \beta - 2\alpha_m \alpha$.

The rms emittance growth due to beam mismatch, whatever the beam distribution, can be given by [4]

$$\xi = \frac{\varepsilon_{\text{rms,mismatched}}}{\varepsilon_{\text{rms,matched}}} = \frac{1}{2} \left((1+M)^2 + \frac{1}{(1+M)^2} \right) = \frac{\Delta}{2}, \quad (2)$$

and the total emittance growth is given by

$$\eta = \xi + \sqrt{\xi^2 - 1} = (1+M)^2 = \frac{\Delta + \sqrt{\Delta^2 - 4}}{2}. \quad (3)$$

In addition, filamentation of the particle distribution in phase space can cause emittance growth. Progress has been made in understanding halo production due to the parametric resonances between single particle and the oscillating mismatched beam core. The mismatch of DC beams is described by two well-known eigenmodes. For bunched beams, there are three eigenmodes [5], a pure

transverse quadrupole mode

$$\sigma_{\text{env,Q}} = 2\sigma_t, \quad (4)$$

and a high mode, and a low mode, which couple the transverse and longitudinal directions

$$\sigma_{\text{env,H}}^2 = A+B, \quad \sigma_{\text{env,L}}^2 = A-B, \quad (5)$$

with

$$A = \sigma_{t0}^2 + \sigma_t^2 + \sigma_{l0}^2/2 + 3\sigma_1^2/2$$

$$B = \sqrt{(\sigma_{t0}^2 + \sigma_t^2 - \sigma_{l0}^2/2 - 3\sigma_1^2/2)^2 + 2(\sigma_{t0}^2 - \sigma_t^2)(\sigma_{l0}^2 - \sigma_1^2)},$$

where σ_t , σ_{t0} , σ_1 and σ_{l0} are the full and zero current transverse and longitudinal phase advance. With smooth approximation, one can get the corresponding Eigen-solutions for the quadrupole mode

$$\Delta a_x/a = -\Delta a_y/a = A_m \cos(\sigma_{\text{env,Q}} s/L + \phi), \quad \Delta b/b = 0, \quad (6)$$

and for high and low mode

$$\Delta a_x/a = \Delta a_y/a = g_{\text{H/L}} \Delta b/b = A_m \cos(\sigma_{\text{env,H/L}} s/L + \phi), \quad (7)$$

where

$$g_{\text{H/L}} = \frac{\sigma_{t0}^2 - \sigma_t^2}{\sigma_{\text{env,H/L}}^2 - 2(\sigma_{t0}^2 + \sigma_t^2)}, \quad (8)$$

g_{H} is always positive and g_{L} is always negative, a is transverse beam size and b is longitudinal beam size. This approximation is not valid for extensively elongated bunches. The above formula are not exactly the same as those at Ref. [5], we think that this is the author's clerical error and the detailed derivation can be found at Ref. [6].

According to the above analysis, for convenience we can use beam size differences to characterize the mismatch, so the Twiss parameters can be represented by the following expression for one mismatch factor M , which is signed "+",

$$\beta = (1+M)^2 \beta_m, \quad \alpha = (1+M)^2 \alpha_m, \quad \Delta a/a = M. \quad (9)$$

In addition, there is another case, shown by the following expression, which is signed "-",

$$\beta = \beta_m/(1+M)^2, \quad \alpha = \alpha_m/(1+M)^2, \quad \Delta a/a = -M/(1+M). \quad (10)$$

For convenience, we define the quadrupole mode mismatch factor as $M_{\text{Q}} = \Delta a/a$ and the high and low mode mismatch factor as $M_{\text{H/L}} = \Delta b/b$ in this paper.

3 Multiparticle simulation results

In the multi-particle simulation, we track 5×10^6 particles with 5σ & 6σ Gaussian distribution. In the mismatch study, the transverse and longitudinal rms emittance growths are controlled to be smaller than 25% and 20%, respectively, which is the same emittance growth level caused by misalignment errors and field errors.

3.1 Filamentation effect

Firstly, we study the filamentation effect with space charge leading to emittance growth. For the longitudinal mismatch, the rms emittance growths with different mismatch factors are shown in Fig. 2. The simulation results agree well with the theoretical values given by Eq. (2). Transverse emittance growth is caused by the space charge effect. Considering the symmetry in the transverse plane of the solenoid focusing structure, we only simulated the dynamic results with mismatch in the x plane and the emittance growth in three planes is shown in Fig. 3. The emittance growth in the y plane is due to the x/y coupling caused by the solenoid and the space charge effect. The difference in emittance growth in the two transverse planes happens because of the difference in the matched beam size at the Spoke040 section, which is caused by the field asymmetry of Spoke040 cavity. From the simulation results, there are beam losses when the transverse mismatch factor is larger than 0.8. For these cases, the transverse mismatch factor should be smaller than 0.5 to meet the design requirement and the longitudinal mismatch factor should be smaller than

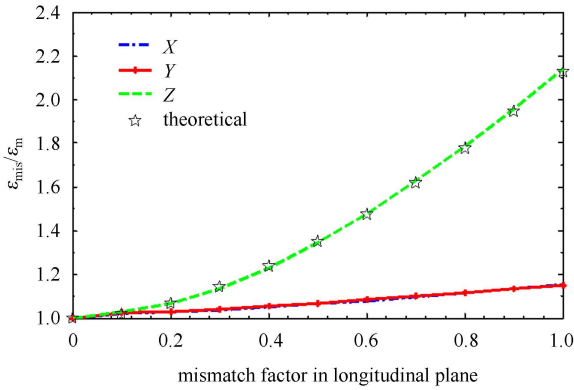

Fig. 2. (color online) RMS emittance growths at linac exit caused by mismatch in longitudinal plane.

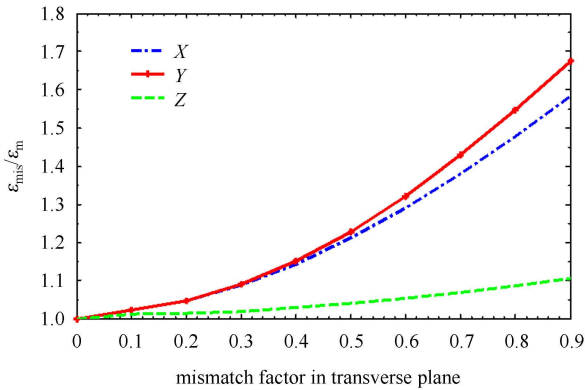

Fig. 3. (color online) RMS emittance growths at linac exit caused by mismatch in transverse plane.

Table 1. Emittance growth caused by mismatch in one plane.

| mismatch factor | | | E_x (%) | E_y (%) | E_z (%) |
|-----------------|-----|------|-----------|-----------|-----------|
| x | y | z | | | |
| 0 | 0 | 0 | 2.7 | 3.2 | 4.2 |
| +0.5 | 0 | 0 | 24.5 | 26.6 | 8.0 |
| 0 | 0 | +0.3 | 6.6 | 7.4 | 18.2 |

0.3, as shown in Table 1, where E_x , E_y and E_z means rms horizontal emittance growth, rms vertical emittance growth, and rms longitudinal emittance growth, respectively.

3.2 Envelope modes of mismatched bunched beams

The highest frequency of the high eigenmodes for the C-ADS accelerator is 155° , so there is no envelope instability. Fig. 4 shows the parametric resonance between single particle and envelope oscillation. There is a $1/2$ parametric resonance for the quadrupole mode and low mode and a $1/3$ parametric resonance for the high mode in the C-ADS main linac. The lower order resonances are the most dangerous, and the high mode or low mode can excite a parametric resonance in either the transverse or longitudinal direction, so the low mode should be considered carefully.

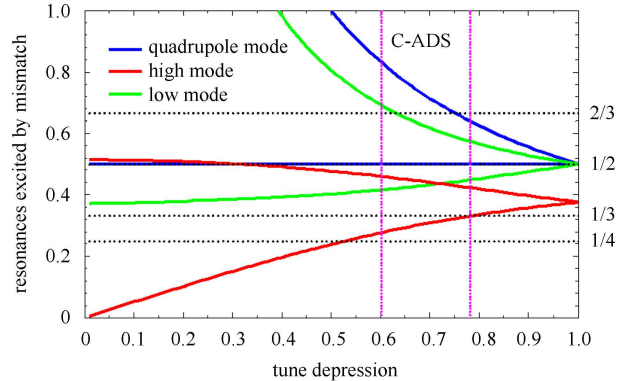

Fig. 4. (color online) Parametric resonances excited by mismatch.

For the quadrupole mode, one should keep the quadrupole mode mismatch factor smaller than 0.3, which means the transverse mismatch factor should be smaller than 0.4 to meet the requirement. The rms emittance growth is shown in Fig 5. From the simulation results, one can see that the emittance growth in the horizontal direction is larger when the quadrupole mode mismatch factor is larger than 0.5, which happens because of beam loss in the vertical direction during the first few periods and because the coupling effect of solenoid envelope oscillations, shown in Fig. 6, quickly becomes stable. The g_H of the high mode is 0.28 for the C-ADS

main linac, which means that the longitudinal mismatch factor is bigger than the transverse mismatch factor. The emittance growths are shown in Fig. 7; one should keep the longitudinal mismatch factor within 0.3. However, the g_L of the low mode is -1.42 , which means a bigger transverse mismatch; the resulting emittance growths are shown in Fig. 8. The low mode mismatch factor should be smaller than 0.2, which means that the transverse mismatch factor should be smaller than 0.4. The difference in emittance growth between the two transverse planes also arises because of the difference in matched beam size at the Spoke040 section. According to the simulation results shown in Table 2, to meet the emittance growth requirement the transverse mismatch factor should be smaller than 0.4 and the longitudinal mismatch should be smaller than 0.3. The mode mismatch factors in Table 2 are defined at the end of the second section of this paper.

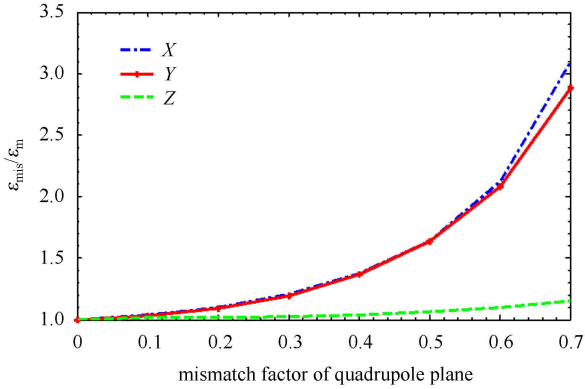

Fig. 5. (color online) RMS emittance growths at linac exit with quadrupole mode mismatch factor.

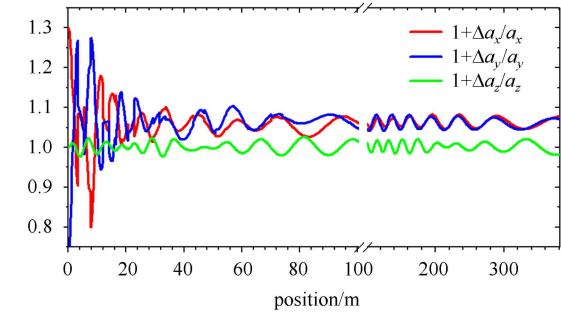

Fig. 6. (color online) Envelope oscillation with 0.3 mismatch quadrupole mode.

Table 2. Emittance growth caused by mismatch.

| mode mismatch factor | mismatch factor | | | E_x (%) | E_y (%) | E_z (%) |
|----------------------|-----------------|-------|-------|--------------|--------------|--------------|
| | x | y | z | | | |
| matched | 0 | 0 | 0 | 2.7 | 3.2 | 4.2 |
| Quad. | 0.3 | +0.3 | +0.43 | 23.9 | 23.3 | 6.9 |
| high | 0.3 | +0.08 | +0.08 | 7.7 | 9.0 | 21.2 |
| low | 0.2 | -0.4 | -0.4 | 28.5 | 30.0 | 15.1 |

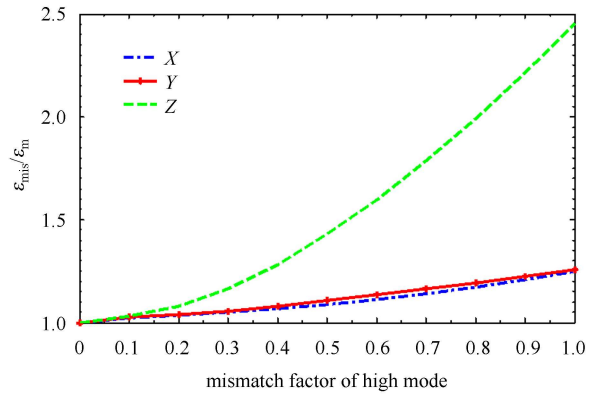

Fig. 7. (color online) RMS emittance growths at linac exit with high mode mismatch factor.

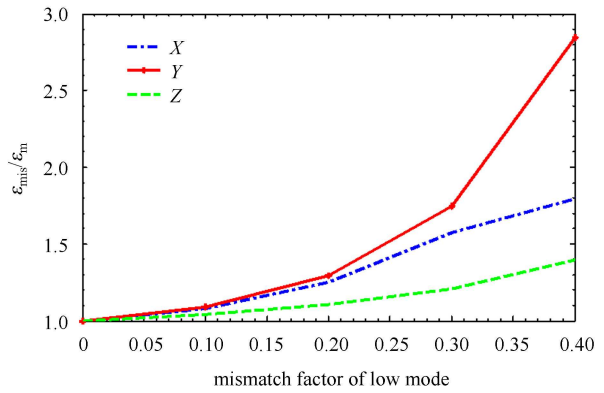

Fig. 8. (color online) RMS emittance growths at linac exit with low mode mismatch factor.

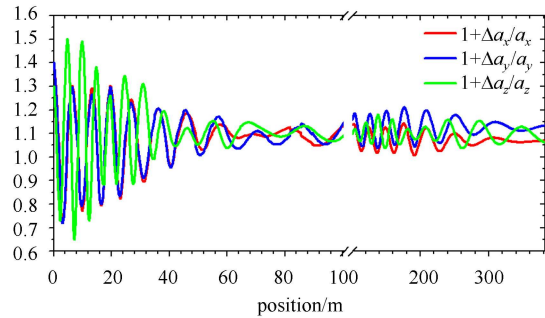

Fig. 9. (color online) Envelope oscillation with 0.4 mismatch in transverse direction and 0.3 mismatch in longitudinal direction.

A mismatch of any amplitude in the transverse and longitudinal directions can simultaneously lead to an excitation of the high and low modes, resulting in larger emittance growths. Fig. 9 shows the envelope oscillation in the longitudinal direction, with the envelope oscillation corresponding to the prediction.

4 Conclusions

The beam halo caused by mismatch is one of the major sources of beam loss. The emittance growth and envelope oscillation caused by mismatch have been studied for the C-ADS accelerator. In this paper, the simulation results of the ADS main linac with beam mismatch are

presented. The transverse mismatch factor should be smaller than 0.4 and the longitudinal mismatch should be smaller than 0.3 to meet the emittance growth requirement.

The authors would like to thank other colleagues in the ADS accelerator physics group for their helpful discussions.

References

- 1 LI Z H, CHENG P, GENG H P et al. Phys. Rev. ST Accel. Beams, 2013, **16**: 080101
- 2 MENG C, LI Z H, TANG J Y et al. Error Analysis and Beam Loss Control in the C-ADS Main Linac. In: Proceedings of IPAC2013. Shanghai, 2013. 3866–3868
- 3 Reiser M. Theory and Design of Charged Particle Beams. New York: John Wiley & Sons. Inc., 1994. 240–250
- 4 TANG J Y. Nuclear Instruments and Methods in Physics Research A, 2008, **595**: 561–567
- 5 Pabst M, Bongardt K. FZJ et al. Progress on Intense Proton Beam Dynamics and Halo Formation. In: Proceedings of 6th European Particle Accelerator Conference. Sweden: 1998. 146
- 6 Gerigk F. Space Charge and Beam Halos in Proton Linacs. In: Proceedings of Joint US - CERN - JAPAN - RUSSIA Particle Accelerator School. California: 2002